



Designing trolleys

A guide to smart trolley design and castor/wheel selection

Castor configuration and wheel size

Large wheels are easier to push.

The most common mistake when fitting castors is to fit wheel diameters too small for the real needs of the trolley and its user. The surveys, both in Australia and overseas, show again and again that small castors which get caught in uneven floors, ridges, gaps and holes, cause many injuries. Large diameter wheels, as against small wheels, will often add less than 10% to the cost of the trolley, and yet make that trolley 500% easier to use.

Castor and wheel guidelines

The guideline is for a minimum diameter of:

- 125mm (5") for non-patient trolleys.
- 175mm (7") for patient trolleys used indoors.
- 200mm (8") for trolleys used out doors or for loads over 200kg (485lb) Smaller castors can still be used in restricted circumstances, for instance, use on lightweight equipment.

In general, castors of:

- 100mm (4") size are recommended up to 120kg (265lb) trolley loads, but only on smooth floors and for short distances. They can be used on ward furniture, but not on catering or hospitality equipment.
- 75mm (3") are even more restricted, being recommended only up to 100kg (220lb) trolley loads and again only on smooth floors without obstructions for short distances.
- 50mm (2") are recommended only up to 80kg (175lb) trolley loads and for very short distances.
- If used on carpets a maximum load of 50kg (110lb) is appropriate.

The research is absolutely clear, large diameter wheels reduce forces for all trolley movements. Larger wheels:





- Are easier to roll along the length of corridors, over ridges, eg. at the edge of carpets, into lifts
- Reduce vibration to patients and equipment and minimise shock transferring to the user's arms from impacts
- Are more robust/resistant to damage, remain functioning efficiently for longer than smaller wheels.

Consider also the other castor features that will effect push effort and ride comfort:



- Tyre material
- Tyre width and profile
- Bearing type (in the wheel and the castor head race)
- Use of threadguards
- Type and number of castor brakes (including directional lock)
- Heavy trolley: fixed at front (eg. hospital beds)
- Light trolleys: fixed at rear (eg. shopping trolleys).

Castor configurations

Traditional configurations

Direction of travel →	Manoeuvrability	Stability	Steering
 <p>4 swivel</p>	<ul style="list-style-type: none"> • Maximum. • Can be moved back & forth and sideways. • Perfect for confined spaces. 	<ul style="list-style-type: none"> • Good except on narrow trolleys. • Up to 4 total brake castors possible. 	<ul style="list-style-type: none"> • Total nightmare! • This is your classic supermarket trolley disaster. • (bi-directional trolley).
 <p>2 swivel 2 fixed or DL</p>	<ul style="list-style-type: none"> • Good except in confined spaces (cannot move sideways). 	<ul style="list-style-type: none"> • Very stable. • Can negotiate ramps easily. • Only 2 total brake castors possible. 	<ul style="list-style-type: none"> • Accurate. • Push with fixed castors leading for long trolleys.
DL (directional lock)			
 <p>2 swivel 2 fixed</p>	<ul style="list-style-type: none"> • Very good except in confined spaces (cannot move sideways). • Warning: Cannot negotiate ramps. 	<ul style="list-style-type: none"> • Fair except if heavy loads placed on corner or if cornering at speed. • Only 2 total brake castors possible. 	<ul style="list-style-type: none"> • Accurate in both directions • (bi-directional trolley).
 <p>4 swivel 2 fixed</p>	<ul style="list-style-type: none"> • High. • Can be turned in own length but not moved sideways. 	<ul style="list-style-type: none"> • Most stable. • Up to 4 total brake castors possible. 	<ul style="list-style-type: none"> • Excellent! • Superbly easy to steer. • (bi-directional trolley).

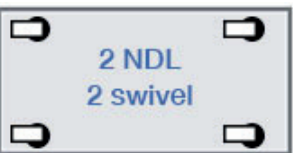
World best practice configurations

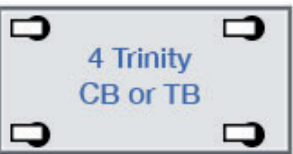
Direction of travel →	Manoeuvrability	Stability	Steering
 <p>2 NDL 2 swivel</p>	<ul style="list-style-type: none"> • Maximum. • Can be moved back & forth and sideways. • Perfect for confined spaces. 	<ul style="list-style-type: none"> • Very stable. • Can negotiate ramps easily. • Up to 4 total brake castors possible. 	<ul style="list-style-type: none"> • Accurate. • Push with NDL castors leading for long trolleys.
NDL (natural directional lock)			
 <p>1 NDL kit 4 swivel</p>	<ul style="list-style-type: none"> • Maximum. • Can be moved back & forth and sideways. • Perfect for confined spaces. 	<ul style="list-style-type: none"> • Most stable. • Up to 4 total brake castors possible. 	<ul style="list-style-type: none"> • Excellent! • Superbly easy to steer. • Push with NDL castors leading for long trolleys.
1x spring-loaded central mount NDL (natural directional lock)			
 <p>4 Trinity CB or TB</p>	<ul style="list-style-type: none"> • Maximum. • Can be moved back & forth and sideways. • Perfect for confined spaces. 	<ul style="list-style-type: none"> • Very stable. • Can negotiate ramps easily. • Up to 4 total brake castors possible. 	<ul style="list-style-type: none"> • Accurate in both directions (bi-directional trolley).
Trinity castors			

Trolley design principles – human factors

Remember the human factor when designing trolleys. You must allow for push forces and other human capacities and limitations.

Trolley weight: As a rough guide, the weight of the trolley is usually 15% to 20% of the load it is to carry. For the castor to function properly, the frame of the trolley must be strong enough to hold the castor head truly vertical so it can swivel freely (that is, the mounting plate must remain horizontal, or the stem must remain vertical), and the frame must not bend under the impacts that inevitably occur. The most common cause of castors not tracking properly is that the mounting has twisted off square.

Heavy trolleys: It is often safer, and more efficient, to divide the heavy load over a number of trolleys rather than concentrating it into one. Trolleys which are too heavy to move commonly remain unused, or people suffer back injuries.

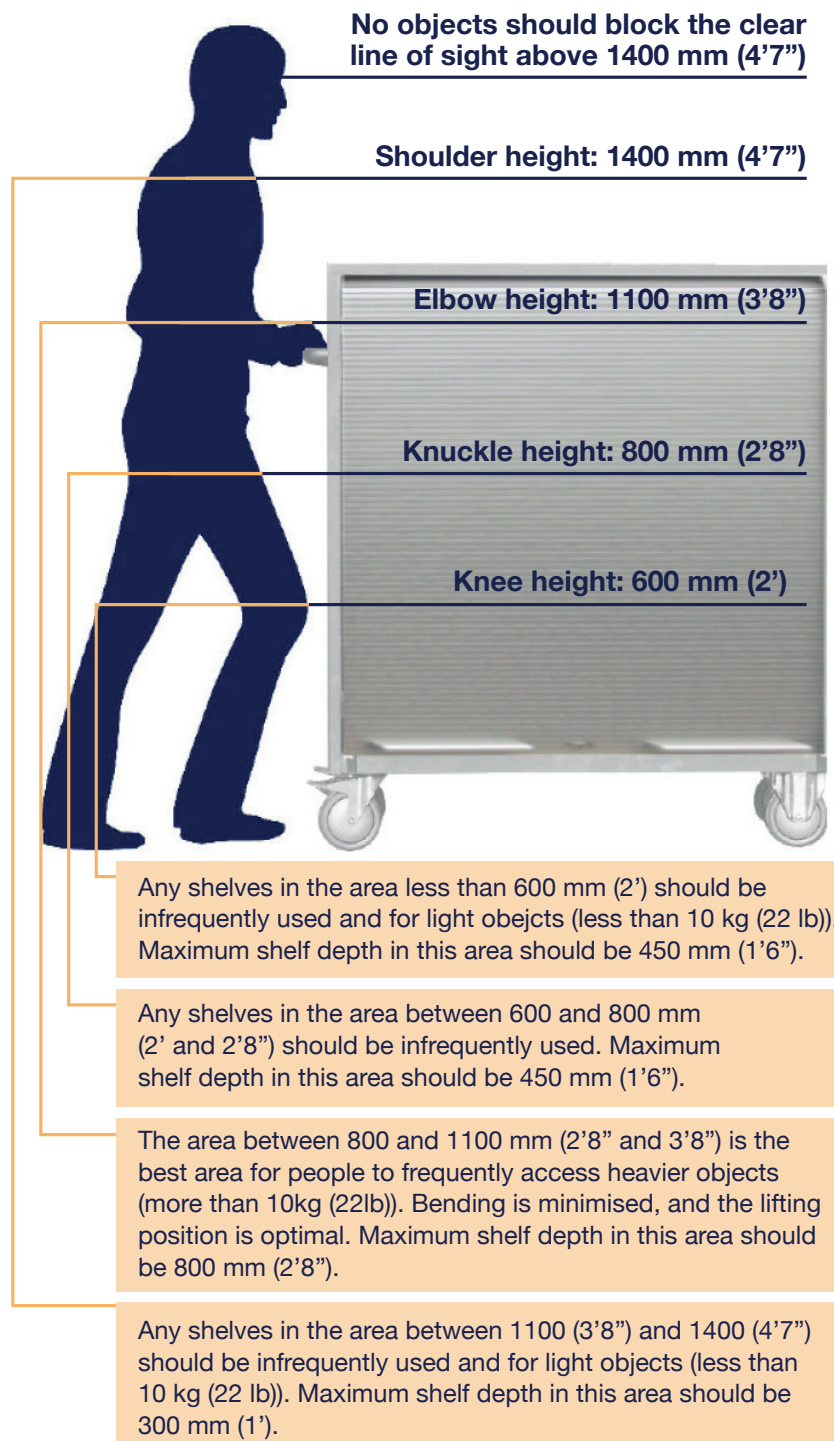

Trolley height

High trolleys which are narrow are particularly dangerous as they lack sideways stability, and can topple, particularly on sloped floors, or if moving around corners quickly.

Sloped floors are more prevalent than you expect, particularly out of doors, or in service areas. In the survey of actual hospitals, the slopes observed were:

- 2.5° in the car park.
- 5.5° on an outdoor covered walkway.
- 8° in an entrance way and 9° on an outdoor ramp.

High trolleys cause users to lean sideways to see past the load, and this causes problems for their backs. The Health Department of Western Australia recommend a maximum trolley height of 1200 mm (even more restrictive).

Tray trolleys are one of the worst offenders for two reasons:

- Because of the light loads they are built high to carry more trays (30 or more).
- Users are often of lower than normal height, which aggravates the problem.

The user survey in the report details complaints about both 30 tray and 20 tray types, and suggests this type of trolley needs some thoughtful redesign.

The injury data, both in Australia and overseas, shows that most (48%) of injuries involving trolleys result from the trolley hitting the injured person. This is sometimes the operator, but frequently a bystander, who is hit by a passing trolley because they were unseen by the operator, due to the trolley being higher than their eyes and “driving blind”.

Recommendation	Reason	If recommendations are not followed
<p>A maximum height of 1400 mm (4'7") is recommended (including the goods being carried) to enable a clear line of sight.</p> <p>Arrange the top of the trolley so no goods can be stored / carried over 1400 mm, so nothing obstructs a clear view when manoeuvring a trolley.</p>	<p>Trolley heights affect trolley stability, available loading volume (and thus load), the height to which objects are lifted to fully load the trolley and visibility.</p> <p>Trolley height of 1400 mm or less allow most users a reasonable view of the area ahead of the trolley. This value is based on 5th percentile female shoulder height (1405 mm) from research by Pheasant 1986.</p>	<p>Allow some visibility through the frame, mesh or bars at eye level of user.</p> <p>Allow for two users with one at front for safety.</p>

Direction/change of travel

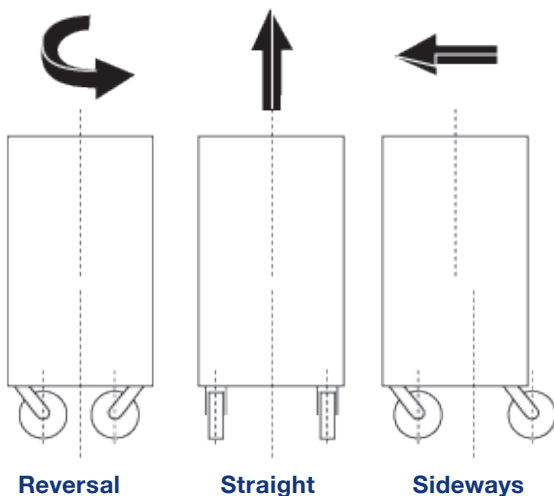

Change of footprint size and centre-of-balance shift increases with size of castor/wheel.

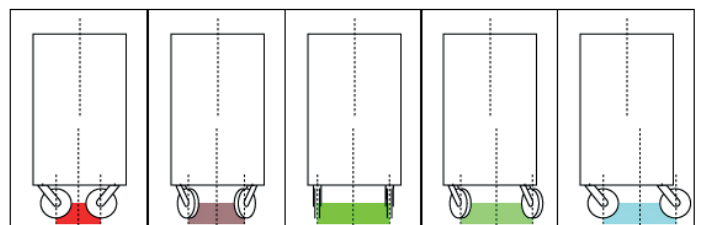

Trolleys used outdoors need bigger diameter wheels to ride over the bumps, but big wheels need bigger offsets – and if the direction of push is reversal and both wheels move inwards the support for the trolley becomes very narrow, and the trolley very unstable. Likewise if the trolley is pushed sideways the centre of balance moves.

Trolley width

Recommendation	Reason	If recommendations are not followed
<p>Hand pushed/pulled trolleys</p> <ul style="list-style-type: none"> The width of hand pushed/pulled trolley (including buffer, etc.) should be at least 80 mm (33/16") narrower than the narrowest doorway. This normally means not much wider than 700 mm if there are standard doorways in use in older hospitals. Newer institutional buildings often have wider doorways that allow for easy trolley movement with 800mm wide trolleys. Trolleys used only in the main aisles (and which do not need to enter the wards) can be even wider. <p>Towed trolleys</p> <ul style="list-style-type: none"> The width of towed trolleys should be 500 mm (17/8") narrower than the narrowest aisle or doorway, and more if towed in a train. This is to allow for the swaying of the trolley. <p>Multiple trolleys</p> <ul style="list-style-type: none"> The width of multiple trolleys should be 700 mm less than the narrowest doorway, as they tend to cut corners. The width of the trolley also affects the sideways stability of the trolley. When you reverse the direction of travel, if both castors swivel inwards, the effect of basewidth is reduced. 	<p>Width affects trolley stability, loading volume, shelf depth, manoeuvrability, and access through doorways.</p> <p>Trolleys must conveniently fit through doorways to provide safety to hands of operators, and to reduce damage to door jambs.</p> <p>Trolleys must not be so wide that users have difficulty placing loads on the shelves.</p> <p>Trolleys must not be so narrow that they become unstable when in use (stability is a function of height and width and castor size / mounting). Castors should be mounted as close to the side of the trolley base as possible.</p>	<p>If slightly too wide, will need to add additional buffering to trolley to protect door jambs, and maybe redesign trolley handles so hands are protected from scrapes. If too wide and access is restricted, there will be more lifting and carrying of loads.</p> <p>If wheel base must be narrow, then height of trolley must be lowered.</p> <p>Tube mounting castors mount further apart than plate mounting castors, and thus increases stability.</p> <p>The width of a trolley is often the dimension that "absorbs" the restrictions on height and length. Given that the height is not to be above 1400 mm and that the length should not be too long, to achieve a certain volume, we tend to widen the trolley.</p> <p>This recommendation ensures that we do not widen the trolley to the point that it will not work easily in the spaces where it needs to go.</p>

The guidelines are:

The distance between axles of castors when both swivel castors are pointing inwards to be at least:

- 2/3 of the trolley width.
- 1/6 of the trolley height if used on level floors, OR
- 1/5 of the trolley height if used on sloped ramps up to 6°.

Sample calculation	
Width of trolley	500 mm
Fitted with 200 mm castors (with axle at 105 mm from edge 2 x 105 mm):	- 210 mm = 290 mm
Distance at axle between inwards facing wheels 290 (x 5 = max trolley height):	(290 x 5) = 1450 mm

- 1450 mm maximum trolley height (from ground) (rounded down to 1400 mm).
- A trolley 1400 mm high could not have a width narrower than 500 mm if fitted with 200 mm castors.

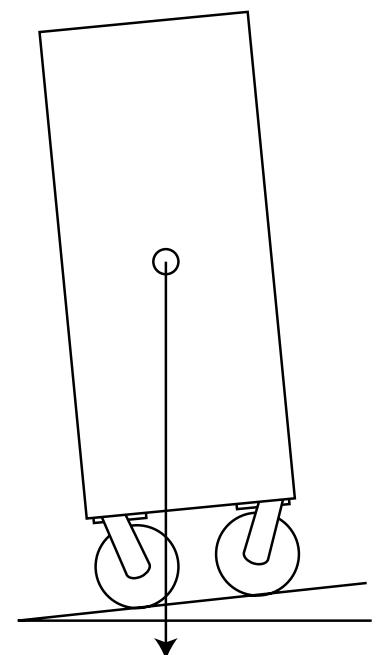

Trolley length

Recommendation	Reason	If recommendations are not followed
Trolley length should be between 1.5 to 2 times its width, otherwise it will not track smoothly around corners.	<p>If too long, the trolley is difficult to steer, or fit into lifts or other small spaces.</p> <p>If too short, operators tend to steer the trolley by twisting their spine.</p>	<p>If the trolley is longer than 2.5 times width, a second person should help steer the trolley. You may also need to experiment to find the best castor arrangement to suit your particular needs.</p> <p>If the trolley is shorter, only lightly load the trolley.</p>

Short trolleys are often used for very light loads and these do not put a strain on the back bones, but as soon as heavier loads go on the trolley (more than say 50 kg) it is better that the trolley becomes more rectangular in shape, with one end clearly the front end having fixed castors (and no handle) and the other end having swivel castors and the steering handle. This encourages the operator to steer the trolley without putting their backbone into torsion.

Trolleys that are too long (even if fixed at the front and swivel at the rear) cause the operator to need to sweep to the side too much to get around corners. Additionally the trolley is too hard to fit into lifts, "or to park".

The more heavily loaded the trolley the more important is is that a long trolley is pushed by two people.

Long trolleys can cause particular problems if towed.

Shelves on trolleys

Shelf height

Recommendation	Reason	If recommendations are not followed
<p>Shelves should be placed so nothing can be placed so any part of it protrudes above 1400mm.</p> <p>A shelf height of:</p> <ul style="list-style-type: none"> • 1100 to 1400 mm (elbow to shoulder) for infrequently use and light items (less than 10 kg). • 800 to 1100 mm (knuckle to elbow) for frequent use and heavy items (above 10 kg). • 600 to 800 mm (knee to knuckle) for less frequent use. • Under 600 mm (below knee) for infrequent use and light items (less than 10 kg). <p>Considered use of self-adjusting units with bin trolleys or platform trolleys to raise loads to good working height.</p>	<ul style="list-style-type: none"> • 1400 mm is the recommended maximum height for a trolley. • 1100 to 1400 mm with lifting above elbow height there is more strain on muscles and joints. • 800 to 1100 mm – this is the strongest working area, and is best for both heaviest and most frequently used units. • 600 to 800 mm – taller people will need to slightly bend to use this shelf. • Under 600 mm too much bending. • Shelf height will adjust to good working load depending on weight of load. 	<ul style="list-style-type: none"> • Training will often be necessary to stop the heavier loads being put onto the lower shelves. • If heavier loads are to be put low it may be necessary to allow knees to face inwards while lifting by recessing knee height shelves. • Platform trolleys and piano are deliberately built low to aid loading heavy large and bulky loads (eg. fridges, furniture, etc.). These are loaded by two or more people who should be trained in shared lifting.

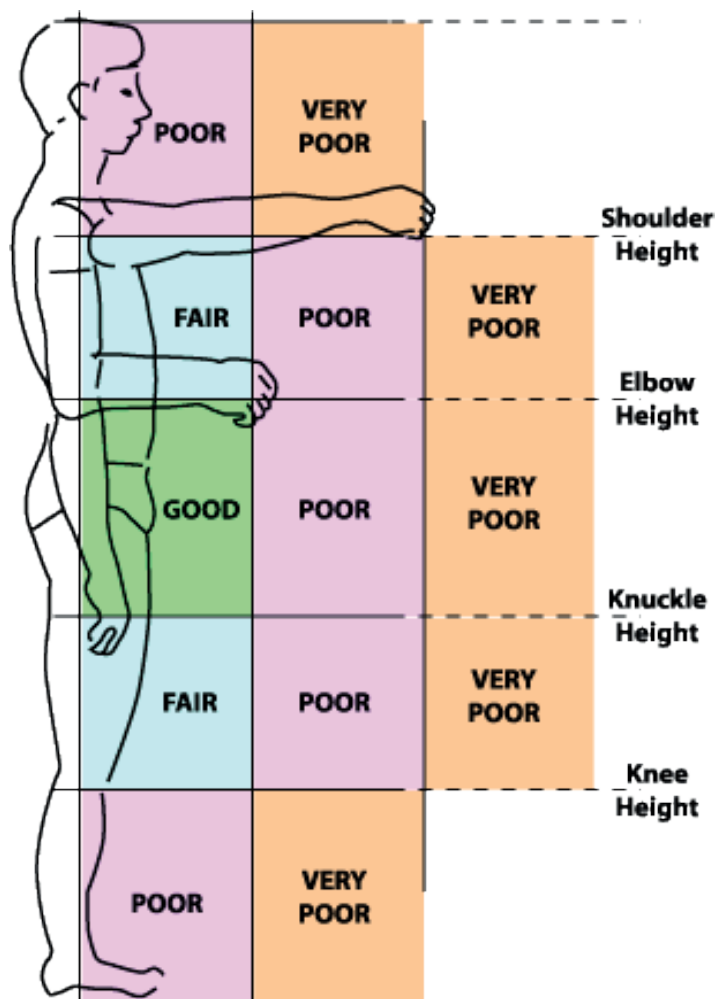

The design of many multi shelved trolleys is almost assured to cause injury.

The image (shown) of the zones illustrates where people are strongest and weakest. Yet so often heavy loads are put too high or too low rather than onto the middle shelves, and too often lower shelves come right to the edge of the trolley so that people cannot bend their knees when lifting or placing a heavy load, thus straining their backs.

Shelf design

The recommendation is that shelves should be smooth so that loads can be slid into place. If there is a chance that this means the loads can shake off the shelves in use, lips or grates are needed. Many times a slight slope inwards on the shelf is enough to stop the load vibrating off. It is bad practice to fit a non-slip surface as this means the load has to be lifted at full arm extension to take it off the shelf. Raised edges which are properly rounded to avoid scratching also work well.

Some shelves need ventilation, (eg. linen carts) and it is often better to use perforated sheeting rather than wire to ensure the load can slide across it.

Recommendation	Reason	If recommendations are not followed
<ul style="list-style-type: none">Shelves should be smooth and either horizontal or sloped slightly inwards.Raised edges or guard rails should be considered.	<ul style="list-style-type: none">Loads should be placed on the edge and slid into place.Sloped shelves resist load sliding off when in use.Raised edges or rails hold loads securely on shelves.	If needing open mesh shelves (eg. linen carts) use lighter unit loads that can be lifted into place.

Shelf depth should not exceed:

- 800 mm at heights of 800 mm to 1200 mm
- 450 mm at heights less than 800 mm
- 300 mm at heights from 1200 to 1400 mm

Avoid small clearances between shelves that make access difficult. It is best for heavy or awkward loads if the shelf can move vertically.

Examples include:

- Scissor action or hydraulic mechanism on flat bed trolleys.
- Retractable bin floors on laundry bins to avoid deep reaching.
- When heavy loads are to be slid into place, this should be done from the front end over fixed castors, as these remain at full mounting width, and cannot turn in, thus reducing support. This needs training and reminder signs.

Trolley sides and gates

Outdoor trolleys often vibrate strongly, and loads easily shake off the shelves causing damage or danger.

For trolleys used outdoors, sides or gates on the trolley are particularly recommended.

Outdoor trolleys that will carry heavy loads should have the sides or gates designed so that two people can get into position to make the lift of the load. If it is a very heavy load the trolley needs to be designed so mechanical equipment (eg. a forklift) can make the lift.

If liquids are to be carried the floor of the trolley should be designed to contain any spills, and to allow those spills to be mopped out of the trolley later (ie. avoid square corners).

Make it easy to detach and refit the sides or gates, and to ensure there are no sharp edges or corners.

Recommendation	Reason
<p>Consider:</p> <ul style="list-style-type: none">Mesh or bars or plate sides.Fixed sides or detachable gates.	<ul style="list-style-type: none">Mesh or bars allow visibility of goods through the trolley, lighter construction.Plates can protect goods from dust, spills, etc.Detachable gates allow access to goods for better manual handling.

Trolley handle details

	Recommendation	Reason	If recommendations are not followed
Handles	<ul style="list-style-type: none"> Fit at least one handle to a trolley 	<ul style="list-style-type: none"> Using the trolley corner posts or side edges risks crushing fingers. 	<ul style="list-style-type: none"> Open top bins with rolled edges may not need handles if top edge is at good height and provides adequate grip..
Handle height and position	<p>Handle should be between 910 and 1000 mm. The optimal handle height for 'average' females is 910 mm (3') Optimal handle height for 'average' males is 990 mm (3').</p> <p>A good compromise handle height for mixed users is 950 mm (3'11/2"). If a trolley is to be pulled (and most are at some time), the handle should be located far enough out from the trolley to ensure feet do not hit the trolley (approx. 400 mm (1'3")). This can be closer if the trolley has no shelves or tubes below 350 mm (1'33/4").</p>	<ul style="list-style-type: none"> The lower height (900 mm) is better if users are mainly women or young males while the upper height (1000 mm) is better if users are mainly adult males. A middle height of 950 mm is a good compromise. 	<ul style="list-style-type: none"> Handles at up to 1090 mm may be appropriate if loads are moved by taller males only. Many existing handles are even higher, but should be restricted to trolleys for lighter loads.
Handle location	<p>If four swivel castors:</p> <ul style="list-style-type: none"> handles at both ends. <p>If two swivel and two fixed castors</p> <ul style="list-style-type: none"> handle only at swivel end. <p>If three swivel castors and one directional lock:</p> <ul style="list-style-type: none"> handle only at other end to directional lock. <p>Handles may be vertical or horizontal. If vertical, allow appropriate space between the two vertical handles (approx. 450 mm).</p>	<p>For greater mobility in confined areas.</p> <p>Fixed castor to the front of the trolley with handle only at rear to prevent users twisting their back to steer.</p> <p>Vertical handles allow users to find their own height, while horizontal handles allow selection of hand separation.</p> <p>450 mm equals shoulder breadth for 95th percentile female and 50th percentile male (from research by Pheasant 1986).</p>	
Handle diameter	From 25 to 40 mm.	Smaller diameters cramp the grip, larger are uncomfortable.	
Handle clearance	<p>Allow a clearance of 115 mm length (to clear palm breadth) by 50 mm (to clear knuckles).</p> <p>Allow a clearance of 200 mm out from back edge of trolleys used at low speed, and 400 mm out for higher speeds.</p> <p>Angle out top edge of push handle on platform trolleys to provide clearance.</p>	<p>To allow hand to grip the handle.</p> <p>Minimum at normal walking speed to ensure ankles do not hit lower shelves when taking good stride length. Can be closer of trolley designed with no shelf or tubes below 350 mm.</p>	
Handle shape	Handles must be cylindrical, smooth and have no sharp edges, seams or 'hot spots'.	Best for safe power grip.	

Trolley handle design

- A good handle does not go right to the edge of the trolley, and thus encourages the user to centralise their push.
- The Health Department of Western Australia recommends 960 mm for fixed handles and a range of 90 to 100 mm for adjustable height handles. This was chosen to obtain optimal height (from British data) for short females and to avoid stooping for 95 percentile males.
- The handle should be at least 50 mm back from the edge of the trolley to clear the knuckles even when the trolley is used in confined areas (if gloved hands are used allow 75 mm). If the trolley is being pushed long distances the handle needs to be 200 mm back from the edge of the trolley if the lower shelf comes fully back to the uprights to allow for a walking stride at slow speeds. If the trolley is to be pushed longer distances (when people tend to stride out) the handle needs to be 400 mm back to avoid the legs hitting the shelves. The handles can be closer if there are no shelves or tubes below 350 mm.
- Allow 115 mm for hand width (or 140 mm gloved) – or at least 300 mm for two hands (325 mm glove). The handle height recommended of 910 to 1000 mm is the same for pushing or pulling, but assumes that the fundamental recommendation limiting force is being observed. The report quotes extensive research to determine the maximum possible push and pull that can be exerted, but, while these are higher than recommendations, they come from abnormal population, eg. fit young male adults. That research revealed different heights for pushing and pulling, and required special floors and shoes to prevent slipping, etc. Such research is not relevant to the mixed population (gender, age, fitness) which forms the users in the general workforce.
- Some research prefers an adjustable T-bar handle for pulling.

Handle height

- The handle height should be between 910 and 1000 mm. This recognises that many users in hospitals are of lower height. Note that the handle height should be adjustable to suit the comfort of individual users, but this is hard to achieve in practice. A heavily loaded trolley where the user has to lean into the load to push it, requires a height towards the lower limit, whereas a more lightly loaded trolley, which is comfortably pushed standing upright, is better with a handle height towards the upper limit. A middle height of 950 mm is a good compromise.

Handle shape

- Handle shapes are conveniently round, and of at least 25 mm diameter. If the trolley is to be used out of doors, it is best to fit rubber or other insulating cover to the handle so that users do not need to touch very hot handles in summer or very cold in winter. The covering material may get 'tacky' with time, and need to be replaced – the design should allow for this.

Handles on trolleys in difficult spaces

- Trolleys used in confined areas often have four swivel castor and these need handles on both ends.
- Trolleys to be pushed longer distances, or on rough or sloped surfaces, need two rigid castors at the front end, and put the handle only on the other end.

Handles are usually horizontal. Vertical handles allow the operator to find their most comfortable height, but are not good for heavy loads as the hand grip is not right. When vertical handles are used they should be clearly inwards from the corner posts, so hands do not become jammed between against walls.

Poor handle design

- Most injuries to users are categorised as 'being caught between the trolley and a hard object' are when the operator's hand is jammed due to poor handle design.
- Regrettably many trolleys in use do not have handles, and users hold the side post; or handles extend right to the edge of the trolley, such that they are the part that bumps the wall when the trolley is turning.

Trolley buffers

Buffers reduce the amount of damage to trolleys, walls, door jambs and other equipment and thus reduce the amount of splinters, metal slivers and roughness that can damage people.

Buffers are an area which requires a lot of new thinking to give the best designs. Buffers have been designed primarily to reduce the amount of damage to trolleys, walls, door jambs and other equipment and thus reduce the amount of splinters, metal slivers and roughness that can damage people. Well applied traditional buffering can still do this. But some injuries are caused by hard buffers running into people and causing direct injury. We really need to concentrate on finding more suitable resilient buffering that protects both trolleys and humans without distorting.

You may need a variety of buffers to suit all the use conditions of the trolley. Certainly buffers are a lot cheaper than re-plastering walls.

Recommendation	Reason	If recommendations are not followed
<p>Appropriate buffers should be fitted and must be made from impact absorbing materials such as rubbers or polyurethane. If trolley is towed the castors must be very heavy duty.</p> <ul style="list-style-type: none">• Side or edge buffers protect trolley sides, door jambs and walls from damage.• Round leg buffers mounted just above the castor on tubular trolleys, rotate along walls and prevent scraping.• Corner buffers cushion trolleys parked against walls.	<p>Think through how the trolley will be used because each different type of buffer is better at reducing different types of damage.</p> <p>More than one type of buffer may be needed for maximum effect, for example, a perimeter buffer.</p>	<p>If buffers are not fitted extra maintenance will be required following regular examinations of trolleys and walls for damage.</p>

Side or edge buffers

Side or edge buffers are mainly mounted to protect door jambs or wall corners as trolleys cut corners.



Round leg buffers

Round leg buffers mounted just above the castor on tubular trolleys rotate along the walls to prevent scrape marks. They work best when the corridor wall has a rubbing strip fitted along the wall at the same height as the round leg buffers.



Corner buffers

Corner buffers are mainly to stop the trolley hitting the wall when being parked.



Trolley towing fixtures

As these guidelines have their full impact, and the loads that people are expected to push are reduced, there will be more use of towing.

In the future this will probably be a mixture of the traditional tractor towing, supplemented by increased use of the small motorised pullers that are attached to one heavy trolley at a time.

The design of trolleys to be towed requires much thought. You cannot just take a trolley designed for manual use and expect it to work well when towed. In the Fallshaw Catalogue there are some design thoughts on towing, but you really need to trial any towing system in practice in the actual environment where it is to be used. Unlike manually pushed trolleys that work reasonably well whenever they are used, towing systems are very much affected by the actual building and grounds in which they must operate, and only a practical test will show up the difficulties.

Castors for manual pushing are normally unsuited for towing. Castor for towing are built to take heavy impact loads (from gutters, ridges, potholes, etc.) and weigh much more than castors for hand pushing.

Recommendation	Reason	If recommendations are not followed
<ul style="list-style-type: none">• Towing fixtures (tow bars, tow hitches, and tow brackets and other couplings) must be designed, constructed and fitted appropriately and adequately. Couplings must be robust and secure.• For towing, heavy duty castors or wheels must be used.• 200 mm minimum diameter.	The location of the couplings, and their location to the trolleys and design of the trolley all affect the safe use of trolleys during towing. Consult the manufacturer's recommendations. Towing causes high impact loads and trolleys and castors must be especially strong.	<p>There can be no exception to careful and adequate design of towed trolleys.</p> <p>Trolleys that break loose at towing speeds are an immediate danger to health and safety.</p>

Trolley materials and structure

Most trolleys used within the ward areas are designed for relatively light loads and made of stainless steel tube and most of them work reasonably well.

Many trolleys used only within the service areas are made to achieve economies of scale and are often too large and made from angle iron or other heavy steel sections, and this often accounts for why many injuries to workers occur in those places.

A rough rule of thumb is that the weight of a trolley should be about 25% of the load for which it is designed.

The design of the trolley from the beginning needs to take account of the users interface, i.e. how the user will put his or her hands onto the trolley and how they will use it. This remembrance of the user right from the beginning will often change the materials used so they are not sharp, or don't rust, or the shape of the materials so that they do not have sharp corners or become rough, or the design so that the trolley does not become too heavy or distortion prone from being too lightly built.

All good design is a compromise, but design that leaves the user out of the equation is simply bad design.

Increasingly, as hospitals work to avoid cross ward infection, trolleys are subject to trolley washing. Both trolley and castor materials need to recognise the detergents and hot water and (often) hot air drying involved in this. And, even when the materials are made non-corroding it will be necessary to frequently replace the grease in the castor head and wheel bearings.

Castors only function well when they are securely mounted to a rigid frame so the swivel axis remains vertical. The adequate rigidity of actual mounting points has to be considered by the trolley manufacturer at the time of designing the trolley. Training material is available for proper fitting of castors. Matters such as tube diameter, tube wall thickness, length of leg extension, etc, are specified in the training material, and need to be given to the designer.

Recommendation	Reason	If recommendations are not followed
Carefully consider trolley materials and the construction of the trolley. Special conditions of use, eg. very hot or cold, or exposure to chemicals or the weather will require special materials or finishes.	Frame material and structure affect trolley weight, rigidity, durability resistance to corrosion, visibility through frame, noise, vibration, type and strength of castor mounting, and potential for cuts, scratches and other injuries. Consults the trolley and castor manufacturers about special requirements. Consider also hygiene and cleaning requirements.	If your conditions of use are severe it is best to trial a sample under actual use conditions.

Trolley push effort

Occupational Health & Safety experts* recommend the following safety suggestions:

Push efforts for trolleys, beds and mobile equipment

Initial force

- 167 – 216N (17 – 21 kg) (37.5 – 46.2 lb)

Sustained force for infrequent, short distances

- 60 – 120N (6 – 12 kg) (13.2 – 26.4 lb)

Spring scales are a simple, accurate way to measure push effort. They are very cheap to buy and are available from most hardware stores. Simply clip the hook of the scale and pull until the trolley begins to move. If it takes less than 17 kg (37.4 lb) to get the trolley moving and less than 6 kg (13.2 lb) to keep it moving, then the trolley design and work load are best-practice.

Most trolleys actually measured in surveys of hospitals* were only within these recommendations if lightly loaded and used on smooth, hard floors. Often, as the trolleys were more heavily loaded up to their design capacity, they exceeded these recommendations, often doubling, and sometimes needing six times the recommended force. For example, simply moving from a hard, smooth floor to a carpeted area could more than double the force required.

* Sources & acknowledgements

"Ergonomic Guidelines for Manually-Handled Trolleys in the Health Industry" a research report (1994) sponsored by Central Sydney Health Service and supported by a grant from Work Safe Australia. Full acknowledgment is made to Judith Lawson (Chief Investigator) and Jules Potiki (Assistant Investigator) and Helen Watson (Research Assistant), and to CSHS and WSA.

This information consists of the recommendations from that report, together with the commentary added by Fallshaw. While based on the health industry, the Recommendations and Commentary are generally applicable.

Experts in mindful moving

MOBILITY SOLUTIONS TO HELP YOU PUSH, PULL & LIFT WITH EASE

Fallshaw Group | 1800 333 002 | sales@fallshaw.com.au | www.fallshawgroup.com.au

Victoria

2A Ayton Street
North Sunshine
VIC 3020

Queensland

Unit 3-4/11 Christensen Road
Stapylton
QLD 4207

New South Wales

Mobile sales:
0437 326 298



Fallshaw
GROUP